

Lige rør med rensesklap - Ø250 mm

Længde m/rensesklap - 250mm

Længde m/rensesklap anvendes hvor der skal være mulighed for fejning.

Dia.	VVS-nr.	A	B	C
5"	3184 10 130	250	205	115
6"	3184 15 150	250	205	100
7"	3184 15 180	250	205	115
8"	3184 15 200	250	190	112
10"	3184 15 250	300	250	124

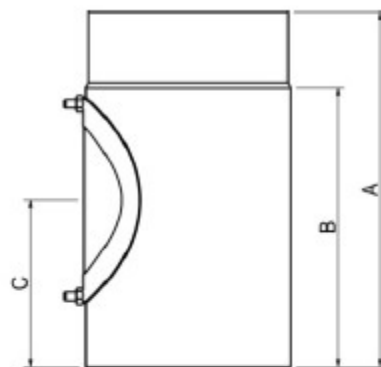

Længde m/rensesklap - 500mm

Længde m/rensesklap anvendes hvor der skal være mulighed for fejning.



Dia.	VVS-nr.	A	B	C
5"	3184 11 130	500	450	223
6"	3184 11 150	500	450	224
7"	3184 11 180	500	450	301
8"	3184 11 200	500	440	300
10"	3184 11 250	540	500	305

